

ETAPY MONTAŻU TORU ORAZ STEROWNIKA RĘCZNEGO

Automatyczny tryb
Dostosuj prędkość

Dla 1-2 graczy

WYSOKI TRYB
Wysoki tryb przeznaczony dla zaawansowanych graczy

NISKI TRYB
Niski tryb przeznaczony dla początkujących.

Baterie DC MODE
Użyj baterii typu 8x1.5V AA

AC MODE
Zasilanie prądem elektrycznym

Zasilanie prądem elektrycznym

Baterie
Użyj baterii typu 8x1.5V AA

12V DC=1000mA

PACE CAR

HI/LO

DC OFF/AC

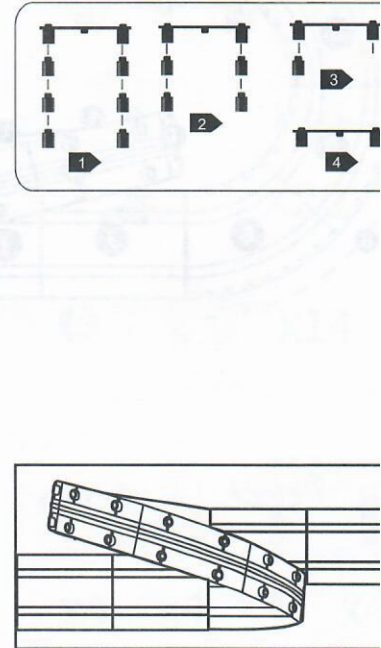
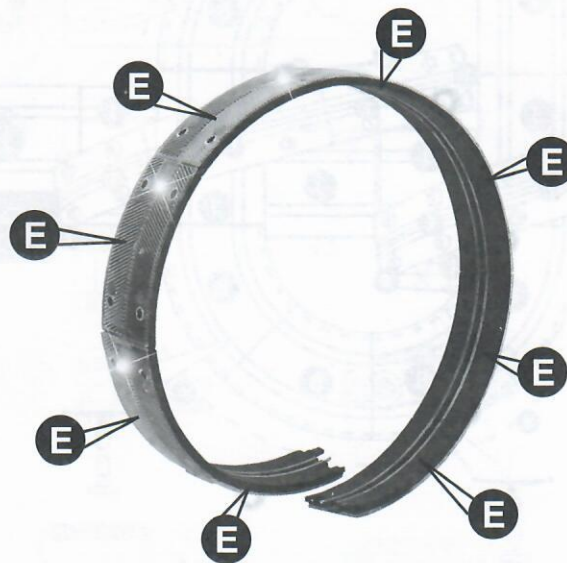
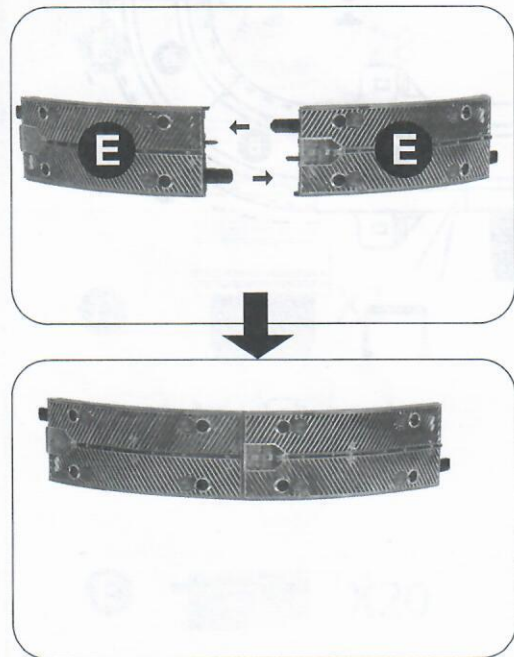
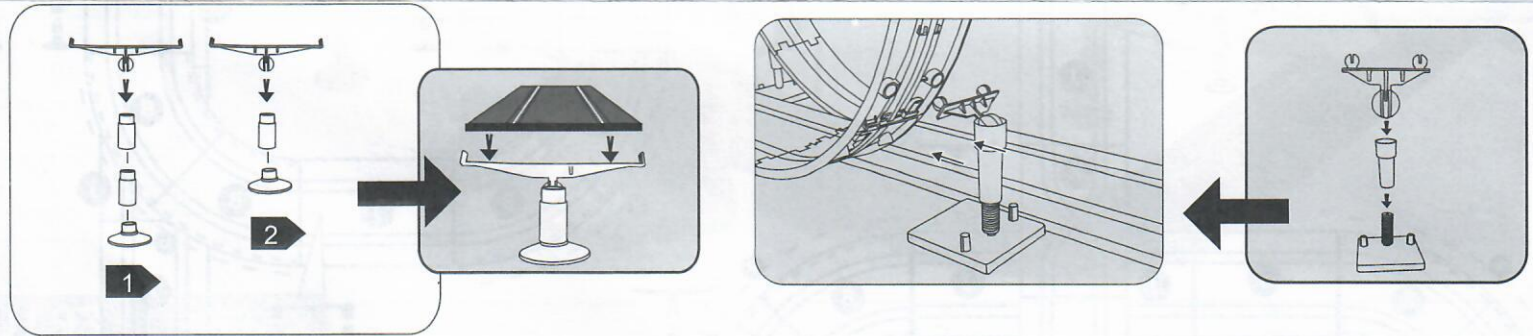

INSTRUKCJA PILOTÓW

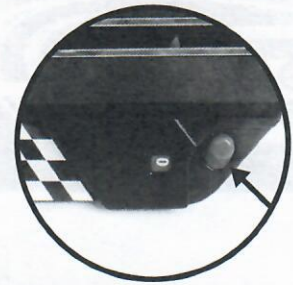
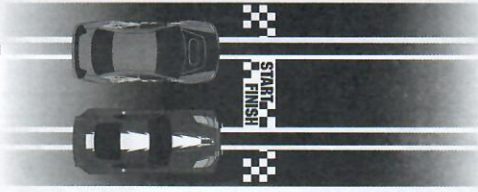
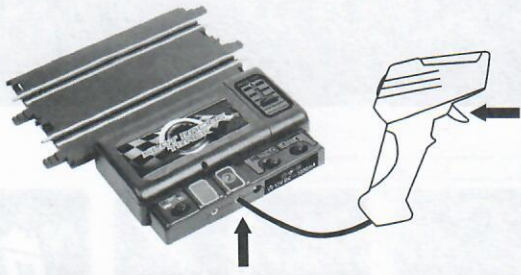

LICZNIK OKRĄŻEŃ

MONTAŻ TORU

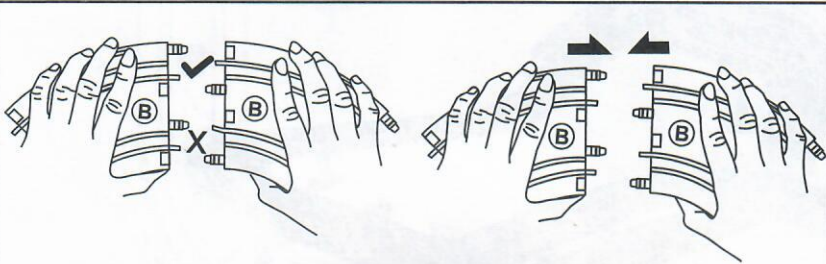

Połącz ze sobą elementy torów.
Nie łącz elementów ze sobą jeśli tor jest zniekształcony.

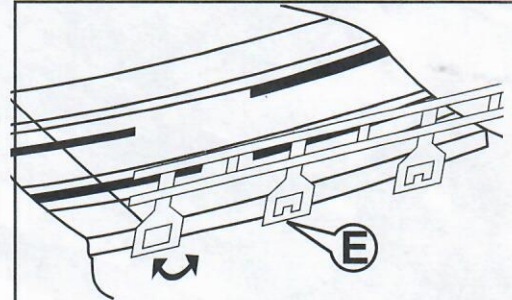

Zamontuj barierki tak jak pokazano na zdjęciu.

MONTAŻ SAMOCHODÓW

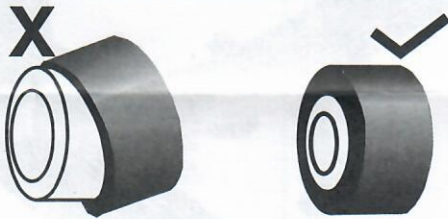

Upewnij się, że koła są ulokowane tak jak pokazano na rysunku.

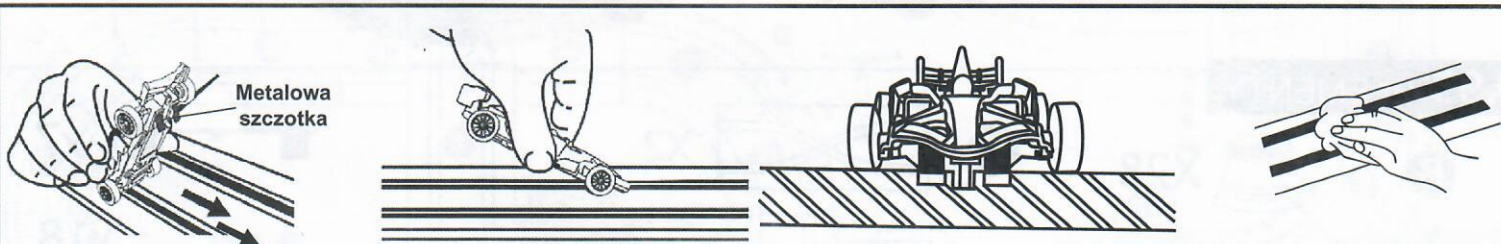
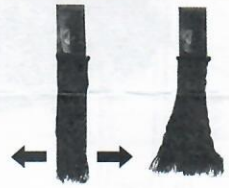
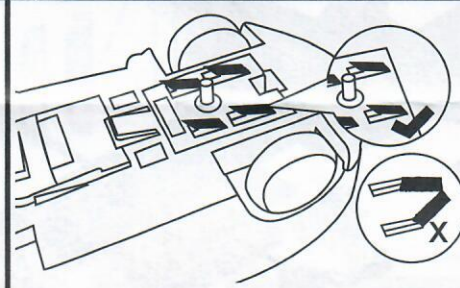

Upewnij się, że szczotki są ustawione w prawidłowej pozycji tak jak pokazano na rysunku.



OSTRZEŻENIE:

RYZYKO ZADŁAWIENIA - zawiera małe elementy
Przeznaczone dla dzieci powyżej 3- go roku życia

MADE IN CHINA







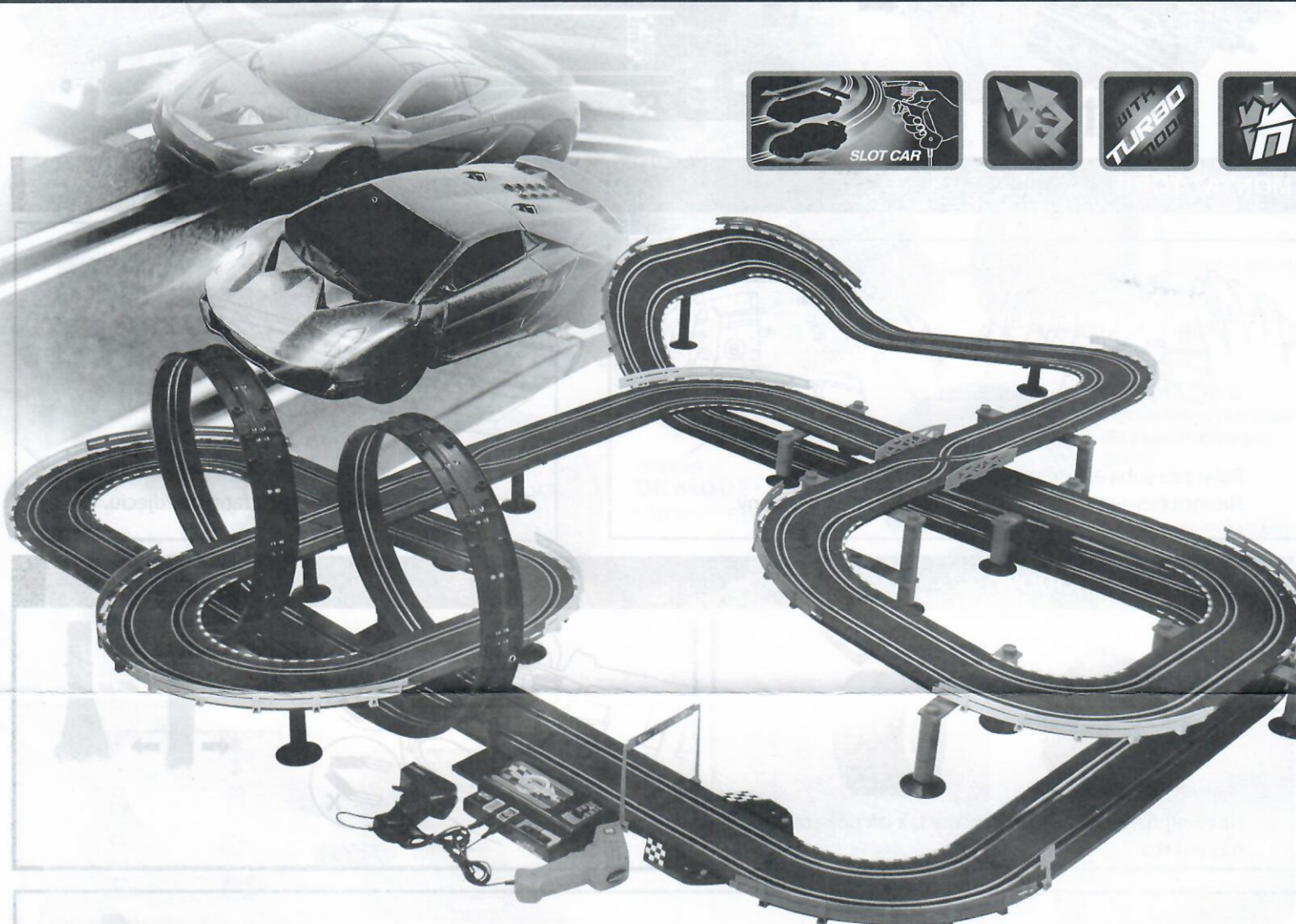





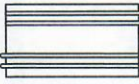





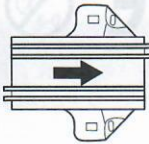



Uwagi:

1. Przeczytaj uważnie instrukcję i postępuj zgodnie z sugerowanymi krokami.
2. Przed użyciem pilotów należy upewnić się, że tory są czyste i nie ma przeszkód na nim. W przeciwnym razie może spowodować zwarcie lub brak prądu na torze wyścigowym.
3. Po 20-30 minutach gry należy użyć suchej szmatki i wytrzeć powierzchnie toru. Upewnij się, że szczotki samochodów są zawsze utrzymane w czystości.

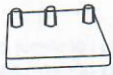

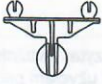
JJ.93 ELEMENTY

- | | | | | |
|-----------|---|--|---|--|
| B |  X28 | X |  X2 |  x7 |
| J |  X32 | D |  X1 |  x7 |
| J1 |  X1 |  X1 |  x14 |  x18 |
| M |  X1 |  X2 |  X2 |  X20 |
| E |  X20 |  X1 |  X2 | R  X14 |
- | | | | |
|--|--|--|--|
|  x4 |  x4 |  x4 |  x4 |
|--|--|--|--|